



MC2200/MC2700 Series Technical Accessory Guide



Does NOT include accessories for MC2100 series. See separate guide for MC2100 series accessories.



NOTE: This document is only for general reference. Solutions Pathway and related PMBs should be used for product availability, pricing, and final solution selection.

** Zebra does not endorse or specifically recommend any **third-party products, accessories, or hardware**. ZEBRA DISCLAIMS ANY AND ALL LIABILITY, INCLUDING ANY EXPRESS OR IMPLIED WARRANTIES, WHETHER ORAL OR WRITTEN, FOR SUCH THIRD PARTY PRODUCTS, ACCESSORIES, OR HARDWARE. THE CUSTOMER ACKNOWLEDGES THAT NO REPRESENTATION HAS BEEN MADE BY ZEBRA AS TO THE FITNESS OF THE THIRD-PARTY PRODUCTS, ACCESSORIES, OR HARDWARE FOR THE CUSTOMER'S INTENDED PURPOSE.*

Cradles and Charging

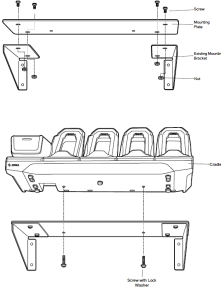

Cradles

Part Number	Picture	Description	Notes	Required Items
CRD-MC2X-2SUCHG-01		Single Slot USB/Charging Cradle	<ul style="list-style-type: none"> ▶ Connects to USB-C port and 2-pin charge contacts on bottom of device. ▶ Supports fast-charging of MC2200/MC2700 device and spare battery. Charges Standard Capacity battery, including spare battery, from 0-90% in less than 3 hours. Charges Extended Capacity battery, including spare battery, from 0-90% in about 4.5 hours. ▶ LED notification of spare battery charging status. ▶ Compatible with devices with hand strap or Pistol Grip Handle attached. ▶ Optional USB to Ethernet Module (MOD-MT2-EU1-01) can be used to convert to Ethernet enabled cradle. ▶ Does not use Zebra ShareCradle design. 	<ul style="list-style-type: none"> ▶ Power Supply (PWR-BGA12V50W0WWW) ▶ DC Line Cord (CBL-DC-388A1-01) ▶ AC Line Cord (23844-00-00R) ▶ USB Cable (25-124330-01R) for PC connection
MOD-MT2-EU1-01		USB to Ethernet Module	<ul style="list-style-type: none"> ▶ Attaches to Single Slot USB/Charge Cradle (CRD-MC2X-2SUCHG-01) to provide Ethernet support ▶ Mechanical switch selects between USB B port and RJ45 Ethernet jack. ▶ 10/100/1000 Mbps speed ▶ LEDs on module indicate connectivity and speed. 	Single Slot USB/Charge Cradle (CRD-MC2X-2SUCHG-01)
CRD-MC2X-1SCU-01		Single Slot Base USB/Charging Cradle	<ul style="list-style-type: none"> ▶ Connects to USB-C connector on bottom of device. ▶ Cradle has an integrated USB-A cable, 3.3 ft. (1m) length. ▶ Charges Standard Capacity battery from 0-90% in less than 3 hours. Charges Extended Capacity battery from 0-90% in about 4.5 hours. ▶ Compatible with devices with hand strap or Pistol Grip Handle attached. ▶ Does not use Zebra ShareCradle design. ▶ Does not charge spare battery. 	▶ USB Power Adapter (PWR-WUA5V12W0US - or country specific version)

CRD-MC2X-5SCHG-01		5-Slot Charge-Only ShareCradle	<ul style="list-style-type: none"> ▶ Will charge up to five devices. ▶ Charges Standard Capacity battery from 0-90% in less than 3 hours. Charges Extended Capacity battery from 0-90% in about 4.5 hours. ▶ Connects to 2-pin Charge Connectors on bottom of device. ▶ Compatible with devices with hand strap or Pistol Grip Handle attached. ▶ Does not charge spare batteries ▶ Can be racked/ mounted in a standard 19 inch rack system via the mounting accessory (BRKT-SCRD-SMRK-01). 	<ul style="list-style-type: none"> ▶ Power Supply (PWR-BGA12V108W0WW) ▶ DC Line Cord (CBL-DC-381A1-01) ▶ AC Line Cord (23844-00-00R)
CRD-MC2X-4SC4BC-01		4-Slot Charge-Only ShareCradle with Spare Battery Charging	<ul style="list-style-type: none"> ▶ Will charge up to four devices and four spare batteries. ▶ Charges Standard Capacity battery, including spare battery, from 0-90% in less than 3 hours. Charges Extended Capacity battery, including spare battery, from 0-90% in about 4.5 hours. ▶ Connects to 2-pin Charge Connectors on bottom of device. ▶ Compatible with devices with hand strap or Pistol Grip Handle attached. ▶ Can be racked/ mounted in a standard 19 inch rack system via the mounting accessory (BRKT-SCRD-SMRK-01). 	<ul style="list-style-type: none"> ▶ Power Supply (PWR-BGA12V108W0WW) ▶ DC Line Cord (CBL-DC-381A1-01) ▶ AC Line Cord (23844-00-00R)
BRKT-SCRD-SMRK-01		5-Slot ShareCradle Mounting Bracket	<ul style="list-style-type: none"> ▶ Allows for rack and wall mounting of one 5-Slot ShareCradle or up to four 4-Slot Spare Battery Chargers. ▶ Bracket can be mounted on standard 19" network rack or on a wall. ▶ Has cable routing slots and removable power supply tray that stores and conceals power supplies. ▶ Adjustable tabs & screw mounts for easy hanging/installation. ▶ Adjustable orientations: <ul style="list-style-type: none"> - 25° High Density (5-Slot Charge Only Cradle) - Horizontal (Single Slot Cradle or 4-Slot Battery Chargers) ▶ See the Bluetooth-Generic Accessories TAG for info on 3rd party Network Racks that can be used for mounting this bracket. 	
ADP-TC7X-PLT-FX		5-Slot ShareCradle Mounting Bracket Adapter Plate for Honeywell	<ul style="list-style-type: none"> ▶ Allows Zebra Multi-Slot ShareCradles to be mounted on legacy Honeywell Flex Cradle Wall Mount Brackets (HON SKU #203-641-002). ▶ Includes hardware to attach plate to HON wall bracket and secure ShareCradle to plate. ▶ NOTE: This is a custom product. Please work with your Zebra representative to open a Custom Product Request (CPR) if you would like to order this cable. 	
Battery Charging				
Part Number	Picture	Description	Notes	Required Items



SAC-MC2X-4SCHG-01		4-Slot Spare Battery Charger	<ul style="list-style-type: none"> ▶ Charges up to four spare batteries. ▶ Standard Capacity batteries will charge from 0-90% in less than 3 hours. Charges Extended Capacity from 0-90% in about 4.5 hours. ▶ Can be used standalone or up to 4 Chargers can be mounted on Mounting Bracket (BRKT-SCRD-SMRK-01) 	<p><u>To power a single Charger</u></p> <ul style="list-style-type: none"> ▶ Power Supply (PWR-BGA12V50W0WW) ▶ DC Line Cord (CBL-DC-388A1-01) ▶ AC Line Cord (23844-00-00R) <p><u>To power two Chargers</u></p> <ul style="list-style-type: none"> ▶ Power Supply (PWR-BGA12V108W0WW) ▶ DC Y-Cable Line Cord (CBL-DC-523A1-01) ▶ AC Line Cord (23844-00-00R)
-------------------	---	------------------------------	---	--



Direct to Device Charging

Part Number	Picture	Description	Notes	Required Items
CBL-TC5X-USBC2A-01 or CBL-TC2Y-USBC90A-01		USB-C cable for Charging/Communication	<ul style="list-style-type: none"> ▶ USB-A to USB-C cable ▶ Attaches to USB-C port on the bottom of the device or to the Single Slot Base Charge/Communication Cradle (CRD-MC2X-BS1CO-01). ▶ Can be used to charge the device via USB connections (PC, USB AC Wall Outlet adapter, USB Cigarette Lighter adapter) ▶ Cable length is 1.5M (~5 ft.) ▶ Will charge battery in device from 0 to 90% in less than 3 hours using the wall-adapter 5V power supply or Cigarette Adapter. ▶ Can also be used to communicate with device without using a Cradle. ▶ CBL-TC2Y-USBC90A-01 features USB-A connector with a 90° bend allowing cable to be used in tighter locations. Cable length is about 1.1M (45"). 	<p>For charging via AC Wall Outlet: USB Power Adapter (PWR-WJA5V12W0US - or country specific version)</p> <p>For charging in-vehicle: USB Cigarette Lighter Adapter (CHG-AUTO-USB1-01)</p>
CBL-TC2X-USBC-01		USB-C cable for Charging/Communication	<ul style="list-style-type: none"> ▶ USB-A to USB-C cable ▶ Attaches to USB-C port on the bottom of the device or to the Single Slot Base Charge/Communication Cradle (CRD-MC2X-BS1CO-01). ▶ Can be used to charge the device via USB connections (PC, USB AC Wall Outlet adapter, USB Cigarette Lighter adapter) ▶ Cable length is 1.5M (~5 ft.) ▶ Will charge battery in device from 0 to 90% in less than 3 hours using the wall-adapter 5V power supply or Cigarette Adapter. ▶ Can also be used to communicate with device without using a Cradle. ▶ NOTE: Recommend using CBL-TC5X-USBC2A-01 which is a lower cost cable solution. 	<p>For charging via AC Wall Outlet: USB Power Adapter (PWR-WJA5V12W0US - or country specific version)</p> <p>For charging in-vehicle: USB Cigarette Lighter Adapter (CHG-AUTO-USB1-01)</p>

3rd party *		USB-C cable for Charging/Communication	<ul style="list-style-type: none"> ▶ USB-A to USB-C cable ▶ Attaches to USB-C port on the bottom of the device or to the Single Slot Base Charge/Communication Cradle (CRD-MC2X-BS1CO-01). ▶ Can be used to charge the device via USB connections (PC, USB AC Wall Outlet adapter, USB Cigarette Lighter adapter) ▶ Will charge battery in device from 0 to 90% in less than 3 hours using the wall-adapter 5V power supply or Cigarette Adapter. ▶ Can also be used to communicate with device without using a Cradle. 	<p>For charging via AC Wall Outlet: USB Power Adapter (PWR-WUA5V12W0US - or country specific version)</p> <p>For charging in-vehicle: USB Cigarette Lighter Adapter (CHG-AUTO-USB1-01)</p>
-------------	---	--	--	--

Communication Cables

Part Number	Picture	Description	Notes	Required Items
CBL-TC5X-USBC2A-01		USB-C cable for Charging/Communication	<ul style="list-style-type: none"> ▶ USB-A to USB-C cable ▶ Attaches to USB-C port on the bottom of the device. ▶ Can be used to charge the device via USB connections (PC, USB AC Wall Outlet adapter, USB Cigarette Lighter adapter) ▶ Cable length is 1.5M (~5 ft.) ▶ Will charge battery in device from 0 to 90% in less than 3 hours using the wall-adapter 5V power supply or Cigarette Adapter. ▶ Can also be used to communicate with device without using a Cradle. 	<p>For charging via AC Wall Outlet: USB Power Adapter (PWR-WUA5V12W0US - or country specific version)</p> <p>For charging in-vehicle: USB Cigarette Lighter Adapter (CHG-AUTO-USB1-01)</p>
CBL-TC2X-USBC-01		USB-C cable for Charging/Communication	<ul style="list-style-type: none"> ▶ USB-A to USB-C cable ▶ Attaches to USB-C port on the bottom of the device. ▶ Can be used to charge the device via USB connections (PC, USB AC Wall Outlet adapter, USB Cigarette Lighter adapter) ▶ Cable length is 1.5M (~5 ft.) ▶ Will charge battery in device from 0 to 90% in less than 3 hours using the wall-adapter 5V power supply or Cigarette Adapter. ▶ Can also be used to communicate with device without using a Cradle. ▶ NOTE: Recommend using CBL-TC5X-USBC2A-01 which is a lower cost cable solution. 	<p>For charging via AC Wall Outlet: USB Power Adapter (PWR-WUA5V12W0US - or country specific version)</p> <p>For charging in-vehicle: USB Cigarette Lighter Adapter (CHG-AUTO-USB1-01)</p>
3rd party *		USB-C cable for Charging/Communication	<ul style="list-style-type: none"> ▶ USB-A to USB-C cable ▶ Attaches to USB-C port on the bottom of the device. ▶ Can be used to charge the device via USB connections (PC, USB AC Wall Outlet adapter, USB Cigarette Lighter adapter) ▶ Will charge battery in device from 0 to 90% in less than 3 hours using the wall-adapter 5V power supply or Cigarette Adapter. ▶ Can also be used to communicate with device without using a Cradle. 	<p>For charging via AC Wall Outlet: USB Power Adapter (PWR-WUA5V12W0US - or country specific version)</p> <p>For charging in-vehicle: USB Cigarette Lighter Adapter (CHG-AUTO-USB1-01)</p>

25-124330-01R		Single Slot Cradle to PC/Host USB cable	<ul style="list-style-type: none"> ▶ Used with Single Slot Base USB/Charging Cradle with Spare Battery Charging (CRD-MC2X-2SUCHG-01) ▶ Micro USB connection on cradle end 	
PSA5BT1E (3rd party) *		Bluetooth Ethernet Adapter	<ul style="list-style-type: none"> ▶ Discontinued ▶ Connects Android Bluetooth devices to Ethernet ▶ Pair as many devices as desired ▶ Supports 5 concurrent Bluetooth connections to one Adapter ▶ PSAK-5BT1E KIT Includes: PSA5BT1E Bluetooth Ethernet Adapter, 5V power supply with AC adapter plugs for worldwide use and Ethernet cable 	
3rd party *		USB micro-A to USB A Female adapter	<ul style="list-style-type: none"> ▶ Allows the MC2200/MC2700 to act as a USB host to connect to devices like USB flash drives/memory sticks, mice, etc. ▶ Connects to Single Slot Base USB/Charging Cradle with Spare Battery Charging (CRD-MC2X-2SUCHG-01). 	







(see <http://www.cyberguys.com/product-details/?productid=33062>)







Snap-On Accessories

Part Number	Picture	Description	Notes	Required Items
TRG-MC2X-SNP1-01		Pistol Grip Trigger Handle	<ul style="list-style-type: none"> ▶ Trigger Handle accessory offers customers the option of using the product in a gun form factor, ideal for scan-intensive situations. ▶ Easily attaches to MC2200/MC2700 top housing ▶ Easily removed to access battery ▶ Integrated 3-point stand for resting terminal when not in use ▶ Connects to I/O connector on rear of device. ▶ Can be used with optional Wrist Tether Strap (50-12500-066) or Handstrap for Gun Configuration (SG-MC2X-HSTRP2-02). ▶ Does not block view of rear facing camera and is compatible with standard and extended capacity batteries. 	

Soft Goods - Cases/Holsters

Part Number	Picture	Description	Notes	Required Items
SG-MC2X-HSTRP-01		Handstrap	<ul style="list-style-type: none"> ▶ This is a spare/replacement handstrap. Handstrap is typically included with each device. ▶ Strap attaches to back of device. ▶ Nylon and Hypalon Pad provides maximum comfort and wear resistance. ▶ Adjustable Velcro design accommodates various hand sizes. ▶ Not compatible with Snap-on accessories (Trigger Handle). ▶ Compatible with devices using Standard or Extended Capacity battery. 	

SG-MC2X-HSTRPH-01		Handstrap for Pistol Grip Gun Handle configuration	<ul style="list-style-type: none"> ▶ This is an optional handstrap for devices with the Pistol Grip Handle attached. ▶ Strap attaches to the bottom of device and to bottom of Pistol Grip Trigger Handle ▶ Nylon and Hypalon Pad provides maximum comfort and wear resistance. ▶ Only compatible with devices using Snap-on Pistol Grip Trigger Handle. ▶ Can be used with devices using Standard or Extended Capacity battery. 	
SG-MC2X-HLSTR-01		Soft Holster for Brick configuration	<ul style="list-style-type: none"> ▶ Vertical orientation with Open Bucket design with strap to secure device in holster while still allowing for easy insertion and removal. ▶ Holster can be worn on belt or cross-body using Shoulder Strap (58-40000-007R). ▶ Non rotating for maximum durability. ▶ Opening at bottom of holster for providing drainage and route for audio from device's speaker. ▶ Compatible with devices with or without Boot attached. ▶ Not compatible with devices with Pistol Grip Handle attached. 	
SG-MC3021212-01R		Fabric Holster for Gun configuration	<ul style="list-style-type: none"> ▶ Only compatible with devices with Snap-on Pistol Grip Trigger Handle attached. ▶ Compatible with devices with or without Boot attached. ▶ This is the same holster used with MC3X series. ▶ Can be mounted on belt or includes tether points to be used with Universal Shoulder Strap (58-40000-007R) 	
SG-MC2X-RB1-01		Rubber Boot for Brick Configuration	<ul style="list-style-type: none"> ▶ Does not increase drop spec of device. Designed to protect the device from the everyday nicks and dings. ▶ Compatible with holster (SG-MC2X-HLSTR-01). ▶ Not compatible with devices with Pistol Grip Trigger handle attached. ▶ Boot must be "peeled back" or removed before inserting into cradles. 	
SG-MC2X-RBH2-01	coming soon	Rubber Boot for Pistol Grip Gun Handle Configuration	<ul style="list-style-type: none"> ▶ Does not increase drop spec of device. Designed to protect the device from the everyday nicks and dings. ▶ Compatible with holster (SG-MC3021212-01R). ▶ Boot must be "peeled back" or removed before inserting into cradles. 	
58-40000-007R		Universal Shoulder Strap	<ul style="list-style-type: none"> ▶ 1.5" wide, 22 to 50" max. length 	
A1236ST (3rd party)* https://www.shilpitradng.com		Universal Shoulder Strap	<ul style="list-style-type: none"> ▶ Belt is 1 inch wide ▶ Extends to 54 inches ▶ Moulded shoulder pad ▶ Plastic swivel snap hooks 	

11-08062-02R		Belt for holster	<ul style="list-style-type: none"> ▶ Belt is 2 inches wide ▶ Extends to 48 inches ▶ Has improved buckle and softer belt material 	
11-08062-01R		Belt for holster	<ul style="list-style-type: none"> ▶ Belt is 2 inches wide ▶ Extends to 48 inches ▶ Discontinued 9/2009, replaced by 11-08062-02R 	
V6198DW (3rd party) * http://www.ultimacase.com		Belt Extender	<ul style="list-style-type: none"> ▶ Used to extend the holster belt (11-08062-02R) an additional 10 inches 	
50-12500-066		Wrist Strap for Trigger Handle	<ul style="list-style-type: none"> ▶ Attaches to bottom of Snap-on Pistol Grip Trigger Handle (TRG-MC2X-SNP1-01) 	
Misc				
Part Number	Picture	Description	Notes	Required Items
SG-STYLUS-TCX-MTL-03 (pack of 3)		Fiber Tipped Stylus	<ul style="list-style-type: none"> ▶ Black Passive Stylus with Zebra logo ▶ 5" length ▶ Heavy duty - made from stainless steel and brass. No plastic parts - real pen feel. ▶ Can be used in rain. ▶ Micro-Knit Hybrid Mesh Fiber Tip provides silent, smooth gliding use. ▶ Big improvement over rubber tipped or plastic tipped stylus. ▶ Compatible with all capacitive touch screen devices. 	
Other Stylus		Rubber or Plastic Stylus	<ul style="list-style-type: none"> ▶ Not supported - Stylus Mode is NOT supported on the MC2200/MC2700. ▶ Hard Plastic/Rubber stylus such as SG-TC7X-STYLUS-03 will not work. ▶ Fiber Tipped Stylus (SG-STYLUS-TCX-MTL-03) will work - does not require Stylus Mode on device. 	
MISC-MC2X-SCRNPT-01 (pack of 5)		Screen Protector	<ul style="list-style-type: none"> ▶ Tempered glass screen protector to provide an extra layer of ruggedness to the Gorilla Glass touch screen of the device. ▶ Provides an oleophobic layer to disperse finger oils. 	



Headset/Audio Accessories

NOTE: MC2200/MC2700 does not have a headset jack. Use a USB-C or Bluetooth headset instead.



Wired Headsets and Audio Accessories









Part Number	Picture	Description	Notes	Required Items
3rd party *		USB-C Headsets	<ul style="list-style-type: none"> ▶ Headset connects via the bottom USB-C connector on device. ▶ Must be Google certified USB-C headset. 	

Bluetooth Headsets and Audio Accessories



Part Number	Picture	Description	Notes	Required Items
See HS2100-HS3100 Accessories Document		HS3100 Rugged Bluetooth Headset	<ul style="list-style-type: none"> ▶ HD Voice, also known as Wide Band Audio, brings incredible audio clarity ▶ Built to handle the everyday inevitable drops ▶ Dustproof, sprayproof and waterproof ▶ Ready for the freezer and outdoor subzero temperatures ▶ Feather-light for extraordinary comfort ▶ Noise cancellation for a superior voice experience in the noisiest environments ▶ Swap batteries on the fly — without losing the Bluetooth connection ▶ Split-second tap-to-pair simplicity using NFC. ▶ Detachable swivel boom minimizes costs. ▶ Swivelling boom mutes microphone allowing uses to prevent voice pick applications from recognizing non-voice pick conversations. ▶ User-replaceable pads and windscreens maximize comfort and hygiene ▶ 15 hours of battery power 	See HS2100/HS3100 Accessories Document for headset accessories
various Bluetooth models B550-XT B350-XT C400-XT C300-XT (3rd party) * http://www.blueparrott.com		BlueParrott Bluetooth Headsets	<ul style="list-style-type: none"> ▶ Various Bluetooth models available with options that include: <ul style="list-style-type: none"> - Blocking out 96% of background noise - Over 24 hours of talk time - NFC Tap to Pair capable - Bluetooth wireless range capable up to 300 ft. - Convertible wearing options: over the head, behind the neck. See BlueParrot site for model specific options.	

<p>3PTY-VXI-B350XT (Zebra orderable SKU)</p> <p>http://www.vxicorp.com</p>		<p>BlueParrott Bluetooth Headset for voice directed applications</p>	<ul style="list-style-type: none"> ▶ Discontinued 10/2018, now use HS3100 series - PMB 10005 ▶ Used to enable Voice Directed Picking (VDP) or Speech Applications in warehouse environments when the use of a wireless headset is desired ▶ Not intended to support peer-to-peer communications (PTT) or VoIP calls. ▶ Provides 24 hours talk time. ▶ Allows the use of other BT devices (i.e. RS5100/RS6000 scanner or mobile printer) ▶ Zebra Compatible certification for VDP application use with MC32. 	
<p>3PTY-VXI-B250XTP (Zebra orderable SKU)</p> <p>http://www.vxicorp.com</p>		<p>BlueParrott Bluetooth Headset for voice directed applications</p>	<ul style="list-style-type: none"> ▶ Discontinued 10/2018, now use HS3100 series - PMB 10005 ▶ Used to enable Voice Directed Picking (VDP) or Speech Applications in warehouse environments when the use of a wireless headset is desired ▶ Not intended to support peer-to-peer communications (PTT) or VoIP calls. ▶ Provides 20 hours talk time. ▶ Allows the use of other BT devices (i.e. RS5100/RS6000 scanner or mobile printer) 	
<p>3PTY-VXI-EXPWAYII (Zebra orderable SKU)</p> <p>http://www.vxicorp.com</p>		<p>BlueParrott Bluetooth Headset for voice directed applications</p>	<ul style="list-style-type: none"> ▶ Discontinued 10/2018, now use HS3100 series - PMB 10005 ▶ Used to enable Voice Directed Picking (VDP) or Speech Applications in warehouse environments when the use of a wireless headset is desired ▶ Not intended to support peer-to-peer communications (PTT) or VoIP calls. ▶ Provides 8 hours talk time. ▶ Allows the use of other BT devices (i.e. RS5100/RS6000 scanner or mobile printer) ▶ Zebra Compatible certification for VDP application use with MC92, VC70, WT41 and MC32. 	
<p>APTT1 (3rd party) *</p> <p>https://www.aina-wireless.com/</p>		<p>Aina Push-To-Talk (PTT) Bluetooth Voice Responder Remote Speaker/Mic (RSM)</p>	<ul style="list-style-type: none"> ▶ Bluetooth speaker-microphone designed to work with different walkie style Push-to-Talk applications, including Zebra PTT Pro (check with Zebra PTT Pro engineering team for current device/OS support). ▶ Includes clip for attaching device to clothing for lapel speaker/mic usage. ▶ Features several buttons which the application developers can assign to different functions. ▶ Users can remotely control functions such as push-to-talk, phone calls, channel switching and emergency alerts. ▶ Device is ruggedized, MIL-STD 810G and IP67. ▶ Long lasting battery designed for 24 hour approx battery life. Can be recharged via micro-USB port. ▶ Includes 3.5mm headset jack allowing headphones to be connected for keeping conversations more private. ▶ Can be easily paired to mobile computer using NFC tap-to-pair. 	

<p>H3-B-1 (3rd party) *</p> <p>https://www.dellking.com</p>		<p>Wandfu H3 Push-To-Talk (PTT) Bluetooth Remote Speaker/Mic (RSM)</p>	<ul style="list-style-type: none"> ▶ Bluetooth speaker-microphone designed to work with different walkie talkie style Push-to-Talk applications, including Zebra PTT Pro (check with Zebra PTT Pro engineering team for current device/OS support). ▶ Includes clip for attaching device to clothing for lapel speaker/mic usage. ▶ Includes 3.5mm headset jack allowing headphones to be connected for keeping conversations more private. 	
<p>BTR-155 (3rd party) *</p> <p>K551011 (Zebra orderable SKU) ▶ Discontinued 3/2019, now order from Savox</p> <p>https://www.savoxaccessories.com</p>		<p>Savox BTR-155 Bluetooth Remote Speaker/Mic (RSM)</p>	<ul style="list-style-type: none"> ▶ Bluetooth speaker-microphone designed to work with different walkie talkie style Push-to-Talk applications, including Zebra PTT Pro (check with Zebra PTT Pro engineering team for current device/OS support). ▶ Includes clip for attaching device to clothing for lapel speaker/mic usage. ▶ Rugged wireless speaker microphone IP55. ▶ Allows cable-free movement ▶ Familiar speaker microphone functions; PTT and volume buttons ▶ Includes 2.5mm headset jack allowing headphones to be connected for keeping conversations more private. ▶ LED status indication ▶ High speaker volume ▶ Includes: <ul style="list-style-type: none"> - Savox RSM - Modular Wired earpiece - Wall Charger - USB Cable - Quick Start Guide - Carrying Strap 	
<p>BTH-101 (3rd party) *</p> <p>https://www.savoxaccessories.com</p>		<p>Savox Push-To-Talk (PTT) Bluetooth Headset</p>	<ul style="list-style-type: none"> ▶ Bluetooth headset designed to work with different walkie talkie style Push-to-Talk applications, including Zebra PTT Pro (check with Zebra PTT Pro engineering team for current device/OS support). ▶ Also operates as standard Bluetooth headset for taking phone calls. ▶ Device is lightweight and ruggedized, IP55. 	
Power Cords/Power Supplies				
Part Number	Picture	Description	Notes	Required Items

CBL-DC-388A1-01		DC Power Cord	<ul style="list-style-type: none"> ▶ Used along with Power Supply PWR-BGA12V50W0WW to power Single Slot Base USB/Charging Cradle with Spare Battery Charging (CRD-MC2X-SE1ET-01) or 4-Slot Battery Charger (SAC-MC2X-4SCHG-01). ▶ Cable length is 1.8 meters 	
PWR-BGA12V50W0WW		Power Supply	<ul style="list-style-type: none"> ▶ Used to power Single Slot Base USB/Charging Cradle with Spare Battery Charging (CRD-MC2X-SE1ET-01) or 4-Slot Battery Charger (SAC-MC2X-4SCHG-01). ▶ 100-240 VAC, 12V, 4.16A, 50W ▶ Provides US DOE Level VI compliance for power efficiency. ▶ Replaces PWRS-14000-148R 	<ul style="list-style-type: none"> ▶ DC Line Cord (CBL-DC-388A1-01) ▶ AC Line Cord (23844-00-00R)
KIT-PWR-12V50W		Power Supply Kit	<ul style="list-style-type: none"> ▶ Includes Power Supply (PWR-BGA12V50W0WW) and DC Line Cord (CBL-DC-388A1-01) 	<ul style="list-style-type: none"> ▶ AC Line Cord (23844-00-00R)
PWRS-14000-148R		Power Supply with integrated DC Cord	<ul style="list-style-type: none"> ▶ Discontinued 1/2017, now use PWR-BGA12V50W0WW and CBL-DC-388A1-01 - see PMB 2923 and PMB 2851 ▶ Replaces KT-14000-148R ▶ 100-240 VAC, 12VDC, 3.33A ▶ Energy Star Compliant 	<ul style="list-style-type: none"> ▶ AC Line Cord (23844-00-00R)
50-14000-148R		Power Supply with integrated DC Cord	<ul style="list-style-type: none"> ▶ Discontinued 12/2007 - replaced by KT-14000-148R 	<ul style="list-style-type: none"> ▶ AC Line Cord (23844-00-00R)
KT-14000-148R		Power Supply with integrated DC Cord	<ul style="list-style-type: none"> ▶ Replaces 50-14000-148R ▶ Discontinued 12/2010 - now use PWRS-14000-148R 	<ul style="list-style-type: none"> ▶ AC Line Cord (23844-00-00R)
CBL-DC-381A1-01		DC Power Cord	<ul style="list-style-type: none"> ▶ Used to power 5-Slot ShareCradles when using Level VI Efficiency power supply (PWR-BGA12V108W0WW) ▶ This cable does not include the black extension release latch which is not required when used on Multi-Slot ShareCradles. 	
CBL-DC-382A1-01		DC Power Cord	<ul style="list-style-type: none"> ▶ Used to power 5-Slot ShareCradles when using Level VI Efficiency power supply (PWR-BGA12V108W0WW) ▶ Cable has black extension tab for releasing the cable from the back of the cradle. This isn't required when using Multi-Slot ShareCradles. ▶ CBL-DC-381A1-01 is the preferred cable to use with MC22/MC27 cradles. 	
50-16002-029R		DC Power Cord	<ul style="list-style-type: none"> ▶ Used to power 5-Slot ShareCradles 	

PWR-BGA12V108W0WW		Power Supply	<ul style="list-style-type: none"> ▶ Replaces PWRS-14000-241R ▶ Used to power 5-Slot ShareCradles ▶ 9A, 108W ▶ Level VI Efficiency rated 	<ul style="list-style-type: none"> ▶ DC Power Cord (CBL-DC-382A1-01) ▶ AC Line Cord (23844-00-00R)
PWRS-14000-241R		Power Supply	<ul style="list-style-type: none"> ▶ Discontinued 2/2017, now use PWR-BGA12V108W0WW - PMB 2851 and 2933 ▶ Replaces 50-14000-241R ▶ Used to power 5-Slot ShareCradles ▶ 100-240VAC, 12VDC, 9A ▶ Energy Star Compliant 	<ul style="list-style-type: none"> ▶ AC Line Cord (23844-00-00R)
50-14001-004R		Power Supply	<ul style="list-style-type: none"> ▶ Discontinued 12/2007 - replaced by 50-14000-241R ▶ Used to power 5-Slot ShareCradles 	<ul style="list-style-type: none"> ▶ AC Line Cord (23844-00-00R)
50-14000-241R		Power Supply	<ul style="list-style-type: none"> ▶ Replaces 50-14001-004R ▶ Used to power 5-Slot ShareCradles ▶ Discontinued 12/2010 - now use PWRS-14000-241R 	<ul style="list-style-type: none"> ▶ AC Line Cord (23844-00-00R)
23844-00-00R		AC Line Cord	<ul style="list-style-type: none"> ▶ Used to power with Power Supplies ▶ This AC Line Cord is for use in North America. See the AC Line Cords by Country TAG for comparable line cords to use in other countries. 	
PWR-WUA5V12W0US (US plug style) PWR-WUA5V12W0GB (UK plug style) PWR-WUA5V12W0EU (EU plug style) PWR-WUA5V12W0AU (Australia plug style) PWR-WUA5V12W0CN (China plug style) PWR-WUA5V12W0IN (India plug style) PWR-WUA5V12W0KR (Korea plug style) PWR-WUA5V12W0BR (Brazil plug style)		USB Power Supply	<ul style="list-style-type: none"> ▶ Used with USB-C Cable to provide a lower cost charging solution than using a Cradle. ▶ Also used to power Single Slot Charge/Communication Base Cradle (CRD-MC2X-1SCU-01). ▶ Provides higher current (2.5A) for faster charging ▶ 100-240 VAC, 5 V, 2.5 A 	<ul style="list-style-type: none"> ▶ USB-C Cable (CBL-TC5X-USBC2A-01 OR CBL-TC2X-USBC-01)
CHG-AUTO-USB1-01 CHG-AUTO-USB1-BR (for Brazil)		USB Cigarette Lighter Adapter	<ul style="list-style-type: none"> ▶ Used with USB-C Cable to provide in-vehicle charging. ▶ Includes two USB A ports providing higher current (2.5A) for faster charging 	<ul style="list-style-type: none"> ▶ USB-C Cable (CBL-TC5X-USBC2A-01 OR CBL-TC2X-USBC-01)
Batteries				
Part Number	Picture	Description	Notes	Required Items

<p>BTRY-MC2X-35MA-01 (single)</p> <p>BTRY-MC2X-35MA-10 (pack of 10)</p> <p>BTRY-MC2X-35MA-BR (for use in Brazil)</p> <p>BTRY-MC2X-35MA-IN (for use in India)</p>		<p>Standard Capacity Spare Battery with PowerPrecision (3500 mAh)</p>		
<p>BTRY-MC2X-49MA-01 (single)</p> <p>BTRY-MC2X-49MA-10 (pack of 10)</p> <p>BTRY-MC2X-49MA-BR (for use in Brazil)</p> <p>BTRY-MC2X-49MA-IN (for use in India)</p>		<p>Extended Capacity Spare Battery with PowerPrecision (4900 mAh)</p>		